

Help Line

Australia	+ 1-800-33-11-77
Canada	+ 1-800-665-4339
México	+ 1-800-234-1185
United States	+ 1-800-955-0959

Fellowes

Australia	+ 61-3-8336-9700
Benelux	+ 31-(0)-76-523-2090
Canada	+ 1-905-475-6320
Deutschland	+ 49-(0)-5131-49770
France	+ 33-(0)-1-30-06-86-80
Italia	+ 39-(0)-71-730041
Japan	+ 81-(0)-3-5496-2401
Korea	+ 82-(0)-2-3462-2884
Malaysia	+ 60-(0)-35122-1231
Polska	+ 48-(22)-771-47-40
Spain	+ 34-91-748-05-01
Singapore	+ 65-6221-3811
United Kingdom	+ 44-(0)-1302-836836
United States	+ 1-630-893-1600

www.fellowes.com



PS-60/PS-65C

Please read these instructions before use.

OPERATION

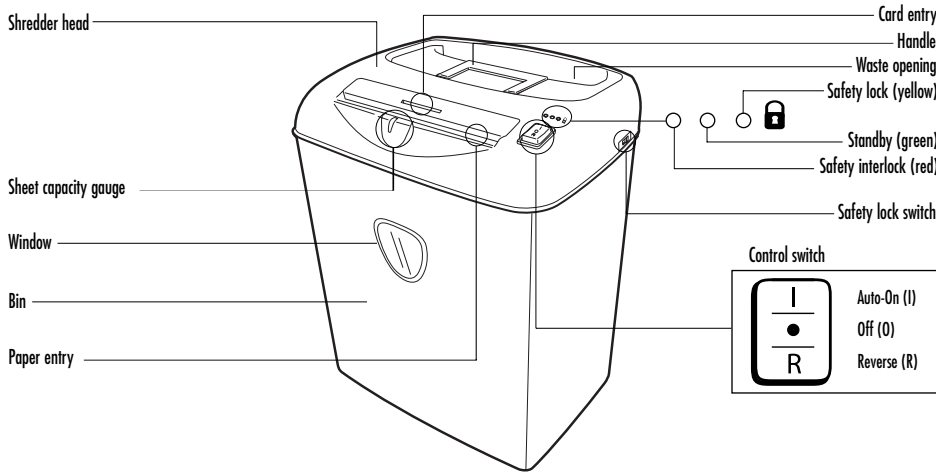

Continuous operation:
10-minute maximum

NOTE: Shredder runs briefly after each pass to clear entry. Continuous operation beyond 10-minutes will trigger 20-minute cool down period.



Set to Off (O) and plug in

PAPER

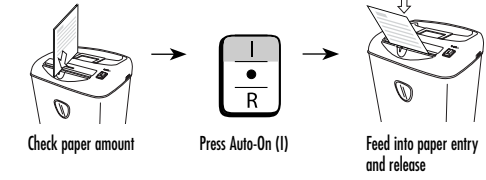

Set to Off (O) and unplug

CARD

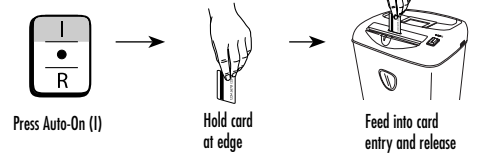

SET UP

Insert waste bag (Fellowes #36052) for easy disposal.

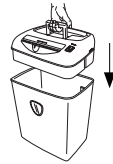

CAPABILITIES

Will shred: Paper, credit cards, staples and small paper clips

Will not shred: Continuous forms, adhesive labels, transparencies, newspaper, cardboard, large paper clips, laminates or plastic other than noted above

Paper shred size:

Strip-Cut.....7/32" (5.8mm)
Confetti-Cut.....5/32" x 2" (3.9 x 50mm)

Maximum:

Sheets per pass (Strip-Cut).....12*
Sheets per pass (Confetti-Cut).....8*
Passes per day.....25-50
Cards per pass.....1
Cards per day.....10
Paper width.....9"/229mm
Continuous operation.....10 minutes

*20lb., 8.5"x11" (75g) paper at 120v, PS-60/PS-65C-2.0Amps; heavier paper, humidity or other than rated voltage may reduce capacity.

IMPORTANT SAFETY INSTRUCTIONS — Read Before Using!

WARNING

- Keep away from children and pets. Always unplug or set safety lock when not in use.
- Keep foreign objects – gloves, jewelry, clothing, hair, etc.— away from shredder entries. In case of accident, press and hold Reverse (R) to back out object.

- Never use aerosol, petroleum-based or other flammable products on or near shredder.
- Do not use if damaged or defective. Do not open shredder head. Do not place near or over heat or water source.

CAUTION

- Avoid touching exposed blades under Confetti-Cut shredder head.
- Use only designated entry for cards.

TROUBLESHOOTING

(Red) Paper jam: Set to Off (O), lift head and empty bin. Replace head on bin and follow any or all of the below procedures.



Press and hold Reverse (R)



Alternate slowly back and forth



Set to Off (O) and unplug

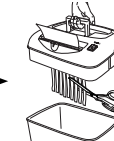

Lift head off bin and cut hanging shreds. Replace head. Plug in.



Press and hold Reverse (R)

Indicator lights:



Make sure head is on basket correctly. Check for jam.



Slide safety lock switch to front to resume shredding

MAINTENANCE

Confetti-Cut and Strip-Cut: Run regularly in reverse for one minute

Confetti-Cut only: Lubricate when bin is full, or immediately, if:
• Capacity decreases
• Motor sounds different, or
• Shredder stops running

Follow oiling procedure below and repeat twice.

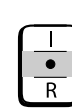

Set to Off (O)



*Apply oil across entry

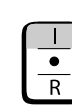

Press Auto-On (I)



Shred one sheet

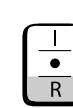

Press and hold Reverse (R) 2-3 seconds

CAUTION *Only use a non-aerosol vegetable oil in long nozzle container such as Fellowes 35250

WARRANTY

LIMITED WARRANTY Fellowes, Inc. ("Fellowes") warrants the cutting blades of the machine to be free from defects in material and workmanship for 5 years from the date of purchase by the original consumer. Fellowes warrants all other parts of the machine to be free of defects in material and workmanship for 1 year from the date of purchase by the original consumer. If any part is found to be defective during the warranty period, your sole and exclusive remedy will be repair or replacement, at Fellowes' option and expense, of the defective part. This warranty does not apply in cases of abuse, mishandling, or unauthorized repair. ANY IMPLIED WARRANTY, INCLUDING THAT OF MERCHANTABILITY OR

FITNESS FOR A PARTICULAR PURPOSE, IS HEREBY LIMITED IN DURATION TO THE APPROPRIATE WARRANTY PERIOD SET FORTH ABOVE. In no event shall Fellowes be liable for any consequential or incidental damages attributable to this product. This warranty gives you specific legal rights. The duration, terms, and conditions of this warranty are valid worldwide, except where different limitations, restrictions, or conditions may be required by local law. For more details or to obtain service under this warranty, please contact us or your dealer.