

Fellowes



PB 2650E

Please read these instructions before use.
Veuillez lire ces instructions avant utilisation.
Lea estas instrucciones antes del uso.

ENGLISH

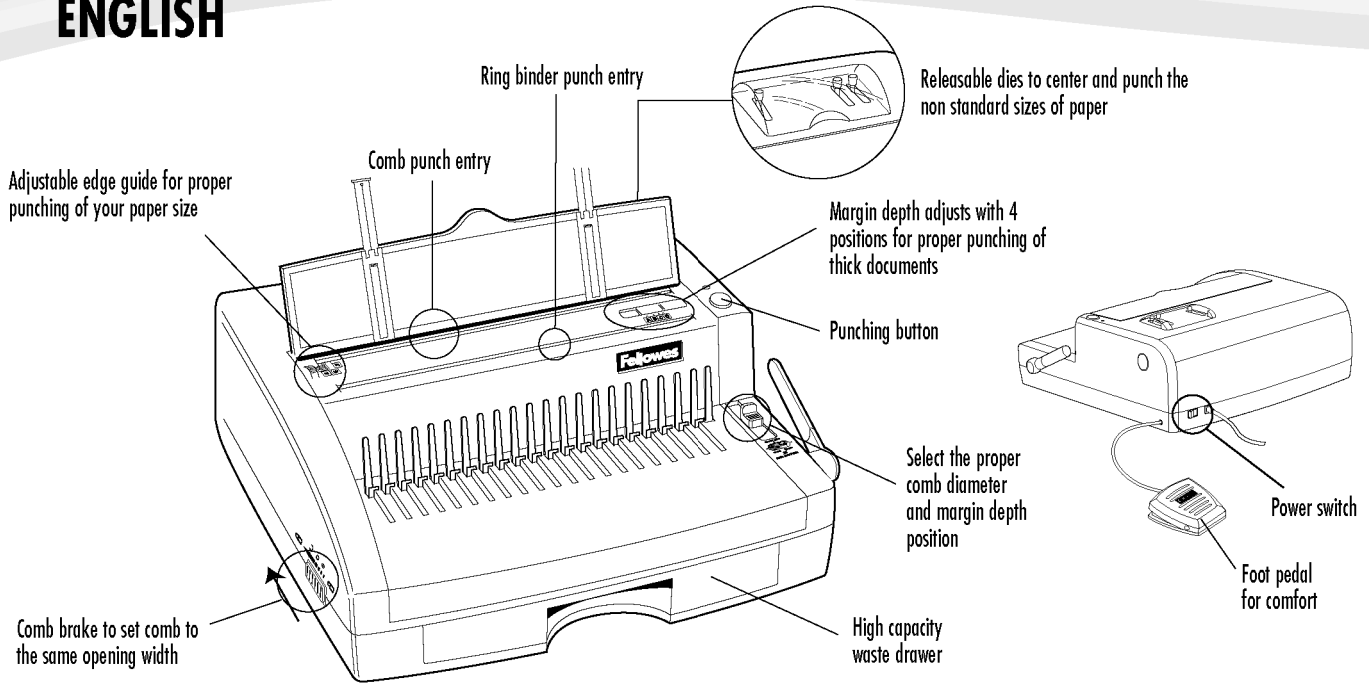

CAPABILITIES

Punching Capacity

<i>Paper sheets</i> 70-80 gram/20 lb.	30
<i>Transparent covers</i> 100-200 microns/4-8 mil	4
200+ microns/8+ mil	2
<i>Other standard covers</i> 160-270 gram/40-60 lb	4
270+ gram/60+ lb	2

Binding Capacity

<i>Comb size</i>	51mm/2 inch
<i>Document length (pages)</i>	500
<i>Adjustable edge guide</i>	Yes
<i>Adjustable margin depth</i>	Yes 4 positions
<i>Comb brake</i>	Yes

IMPORTANT SAFETY INSTRUCTIONS



Read Before Using!

- Remove staples and other metal from sheets before punching.
- Keep the covers closed when the machine is not in use.
- Keep the transparent die cover closed during punching.
- Never attempt to open or otherwise repair these machines.
- Keep it away from heat or water sources.
- Plug it near an easily accessible outlet.
- Turn it off after each use.
- Unplug it when not in use for an extended period.

TIPS

- For optimum performance, do not push your machine beyond its punching capacity.
- For easy reference, you will also find the machine's punching capacity chart below printed on the inside of the waste drawer.

Comb diameter sizes & margin depth adjustments

mm	inch				
6	1/4"	1-20	A		
8	5/16"	21-40	A		
10	3/8"	41-55	B		
12	1/2"	56-80	B		
14	9/16"	81-100	C		
16	5/8"	101-120	C		
18	3/4"	121-150	C		
22	7/8"	151-180	D		
25	1"	181-200	D		
28	1-1/8"	201-240	D		
32	1-1/4"	241-280	D		
38	1-1/2"	281-340	D		
45	1-3/4"	341-410	D		
51	2"	411-500	D		

SET UP

COMB BINDING—Before You Bind

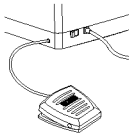

- Electric model**
1. Plug the machine into power outlet.
 2. Also plug the cable of the foot pedal into the jack on the machine.

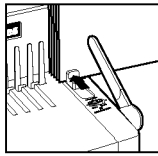

1. Select the comb diameter and margin depth letter.



2. Adjust margin depth.

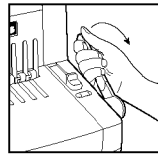

3. Insert the comb. Pull lever to open comb.

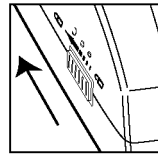

4. Set comb brake if desired.

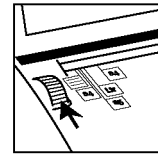

5. Adjust for document size.

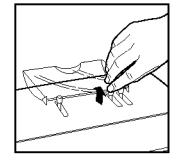

6. Adjust for document size with the releasable dies.

COMB BINDING STEPS

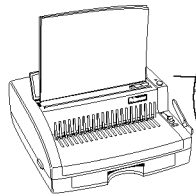

Front Cover

Back Cover

1. Punch front cover and back cover first.

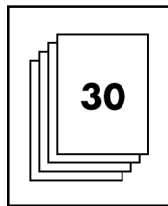

2. Punch the paper in batches of 30 sheets maximum.

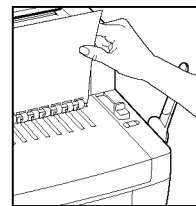

3. Insert pages onto comb as soon as they are punched.

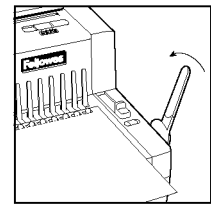

4. Push the comb lever back to close the comb.

RING BINDER PUNCHING

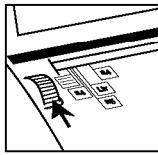

Before you punch:
Adjust for document size with the edge guide.

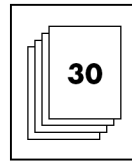
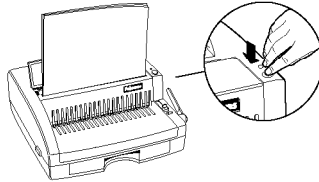

Punch the paper in batches of 30 sheets maximum.

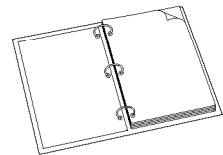

TROUBLESHOOTING

Problem	Cause	Solution
Red standby light	Your machine is jammed, most likely due to punching too many sheets at one time.	Press but do not hold, the start button and wait for the motor to stop. This will clear the jam and the standby light will turn green again.
Partial last hole	Sheets are not properly aligned.	With letter documents, move document wheel to improve centering; with all other formats, make sure the edge guide is in the correct position and the corresponding die has been raised.
Punch holes not parallel to edge	Debris is stuck below the dies.	Take a ruler or stiff cardboard and slide it into the entry, moving it back and forth to release cuttings into the waste drawer.
Damaged hole edges	You may be trying to punch too many sheets at one time.	Reduce the number of sheets per batch.

Need Help?

Customer Service:
00 800 1810 1810
www.fellowes.com

Let our experts help you with a solution.
Always call us first before contacting your place of purchase.

WARRANTY

Fellowes warrants all parts of the binder to be free of defects in material and workmanship for 2 years from the date of purchase by the original consumer. If any part is found to be defective during the warranty period, your sole and exclusive remedy will be repair or replacement, at Fellowes' option and expense, of the defective part. This warranty does not apply in cases of abuse, mishandling or unauthorized repair. ANY IMPLIED WARRANTY, INCLUDING THAT OF MERCHANTABILITY OR FITNESS FOR A PARTICULAR PURPOSE, IS HEREBY LIMITED IN DURATION

TO THE APPROPRIATE WARRANTY PERIOD SET FORTH ABOVE. IN NO EVENT SHALL FELLOWES BE LIABLE FOR ANY CONSEQUENTIAL OR INCIDENTAL DAMAGES ATTRIBUTABLE TO THIS PRODUCT. This warranty gives you specific legal rights. You may have other legal rights that vary from this warranty. The duration, terms and conditions of this warranty are valid world-wide, except where different limitations, restrictions or conditions may be required by local law. For more details or to obtain services under this warranty, please contact us or your dealer.

Help Line

Australia	+ 1-800-33-11-77
Canada	+ 1-800-665-4339
México	+ 1-800-234-1185
United States	+ 1-800-955-0959

Fellowes

Australia	+ 61-3-8336-9700
Benelux	+ 31-(0)-76-523-2090
Canada	+ 1-905-475-6320
Deutschland	+ 49-(0)-5131-49770
France	+ 33-(0)-1-30-06-86-80
Italia	+ 39-071-730041
Japan	+ 81-(0)-3-5496-2401
Korea	+ 82-(0)-2-3462-2884
Malaysia	+ 60-(0)-35122-1231
Polska	+ 48-(22)-771-47-40
Spain	+ 34-91-748-05-01
Singapore	+ 65-6221-3811
United Kingdom	+ 44-(0)-1302-836836
United States	+ 1-630-893-1600

www.fellowes.com



1789 Norwood Avenue, Itasca, Illinois 60143-1095 • USA • 630-893-1600

<http://www.fellowes.com>

Australia
Benelux

Canada
China

Deutschland
España

France
Italia

Japan
Korea

Polska
Singapore

United Kingdom
United States